

513

Look ahead!



ENGLISH

Electric wire rope hoists

Crane components

Controlling/Monitoring

Look ahead!

04	12	18	30
			Controlling/ Monitoring
		CraneKit Crane components	NovaMaster TravelMaster RadioMaster Sway Control Tandem operation
	CRABster Winch	End carriages Travelling machineries	
NOVA Electric wire rope hoists			



Content

SWF is one of the leading global players in crane and hoisting equipment. At all times and in all places, SWF applies to the highest and the most demanding standards – those of our customers.

Our customers are independent crane manufacturers, lifting equipment resellers and service companies. They use SWF hoists and components because they perform better, offer advantages and can do more than the average products on the market. Quick decisions and flexible acting makes it easy to deal with SWF furthermore.

Close to every SWF product there stands a reliable local partner who knows precisely what counts. In this way installations are built to perform better, systems to work and last longer – systems with first class service and optimum efficiency, ideally customized to the end users needs.

No one can match what we have to offer.

SWF has one of the most comprehensive product portfolios available. In addition to that we also have a complete service package which includes seamless support, customer specific configuration software, technology and sales training, and a whole range of customer specific

services. We know that our partners will have to offer more than just products to have a competitive edge, and SWF helps them to get it.

“Special” often means special solution, special effort and thus special costs. The SWF components have been designed to be as flexible and cost-effective as possible; allowing us to do a solution adapted to your needs by using standard equipment. This keeps the individual development and the cost that comes with it at a minimum. By using standard components with a proven quality record you also minimize the number of breakdowns, as well as the costs for wear, tear, service and maintenance.

Development going in one direction – upwards.

SWF was founded in 1921 in Germany and has since then been known to deliver high-quality products. Today, products from SWF are used in areas where top performance and top quality are demanded. Performance and quality that today's companies need in order to be successful and dependable.

KRAN IST FERNGESTEUERT

SWF
KRANTECHNIK

8 t

5

KRAN IST FERNGESTEUERT

60 t

8

8 t

911110

04

05

NOVA
Electric wire rope hoists

NOVA

Electric wire rope hoists for loads of up to 80 t



- Optimum utilisation of space**
 Compact installation dimensions and optimum approach dimensions, minimum hook dimensions
- Precise and safe work**
 Minimum lateral hook movements and low load swing thanks to smooth load movement with frequency inverters
- Low maintenance costs**
 The brake designed to extend the lifetime, the larger diameter of the rope drum to protect the load rope, the hoist gear lubricated to extend the lifetime and the smooth cross travelling with the frequency inverter reduces material wear and tear

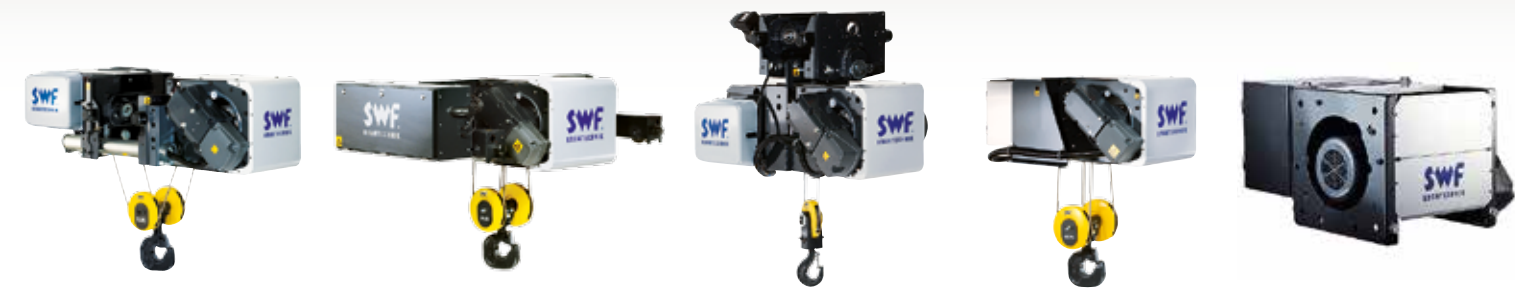

NOVA L
Single girder trolley, low headroom, up to 12,5t

NOVA M
Double girder trolley, up to 80t

NOVA N
Single girder trolley, normal headroom, up to 40t

NOVA F
Fixed hoist for free-standing installations, up to 80t

NOVA machinery hoist, up to 5t

Advantage: Maximum cost effectiveness and optimum utilisation of space

- Loads of up to 80 t
- Single hoist or as a crane kit
- Single or double girder trolley or foot-mounted hoist
- Low lateral hook movement
- Compact installation dimensions
- Optimum approach dimensions
- Stepless cross and long travelling
- Ambient temperature -10°C to +40°C

Type	Reeving	Load t / FEM classification																Design				Lifting speed m/min 50 Hz Standard	Lifting height m	
		1,6	2	2,5	3,2	5	6,3	8	10	13	16	20	25	32	40	50	63	80	F	N	L			M
NB	02	2m																	•	•	•	•	10/1.7	12 - 19
	04				3m 2m														•	•	•	•	5/0.8	6 - 9.5
NC	02		3m 2m	1Am															•	•	•	•	10/1.7	12 - 30
	04				3m 2m 1Am														•	•	•	•	5/0.8	6 - 15
ND	02	22			3m 2m 1Am														•	•	•	•	10/1.7	18 - 40
	04	24				3m 2m 1Am													•	•	•	•	5/0.8	9 - 20
	06	26					3m 2m												•	•	•	•	3.2/0.5	6 - 13
	08	28						3m 2m 1Am											•	•	•	•	2.5/0.4	4.5 - 10
NE	02	22				3m 2m 1Am													•	•	•	•	8/1.3	15.5 - 97
	04	24					3m 2m 1Am												•	•	•	•	4/0.7	7.5 - 48.5
	06	26						3m 2m											•	•	•	•	2.5/0.4	5 - 32
	08	28							2m 1m										•	•	•	•	2.0/0.3	7 - 24
NF	22								3m 2m 1Am										•			•	8/1.3	15.5 - 71
	24									3m 2m 1Am									•			•	4/0.7	10 - 35.5
	26										3m 2m								•			•	2.5/0.4	6.5 - 23.5
	28											2m 2m 1Am							•			•	2.0/0.4	6.5 - 17.5

Subject to change without prior notice. You will find further technical information in our manuals and dimensional drawings.

NOVA

Perfect utilisation of space and almost vertical lifting guarantee so that work is carried out precisely and safely.



Rope guide

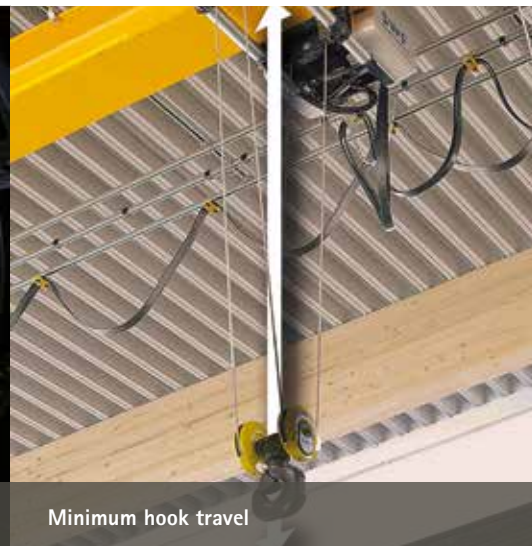

Minimum hook travel

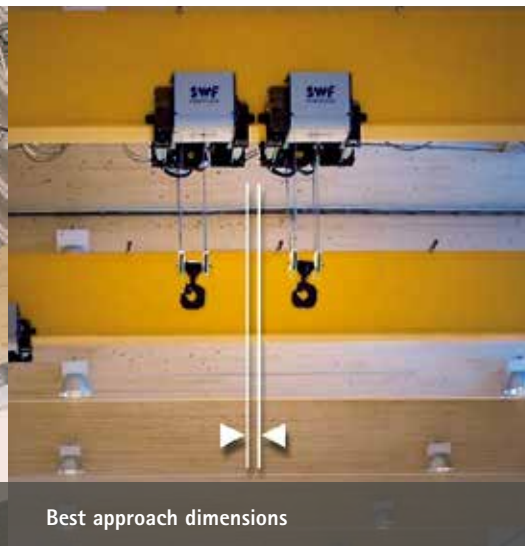

Best approach dimensions



Hoisting gear limit switch



Contactor control with NovaMaster



Stainless steel hoist panel

We have increased the size of the drum, making everything else smaller.

The main feature of our NOVA electric wire rope hoist is the extremely large diameter of the rope drum, which provides first-class protection of the rope, but there are also other features which guarantee safe and very cost-effective use.

NOVA does away with load swinging and lateral hook movement, for example.

NOVA lifts the load with virtually no lateral hook movement at all. Swinging of the load is prevented and secure handling is guaranteed. At the same time, this can help to reduce the costs for the crane design.

NOVA adapts itself to your building.

NOVA offers the best approach dimensions and the smallest installation dimensions in the electric wire rope hoist sector. This ensures the optimum utilisation of space and reduces building costs.



HBC hook

DIN RSN hook

Standard equipment:

- 2-speed hoisting motors (6/1)
- Hoist condition monitoring system NovaMaster with Safe Working Period Counter (NOVA NE/NF)
- 4-step hoisting limit switch with slow-down function and phase mismatch protection
- Electronic overload protection
- Thermal protection for hoisting and travelling motors
- Travelling machinery with frequency inverter, 2-step or stepless
- Standard 3-phase voltages 380/400/415 V 50 Hz; 440/460/480 V 60 Hz
- 48 V contactor control
- IP 55 protection, duty factor 60 %
- Electrical assembly and wiring in accordance with IEC standards
- Robust rope guide made of cast iron
- Epoxy paint, 60 µm

Options:

- IP65 control pendant with plug adapter and Emergency-Stop
- Radio remote control
- Hoist condition monitoring system NovaMaster with Safe Working Period Counter (NOVA NB/NC/ND)
- Load summation for max. 4 hoists with NovaMaster
- Hoisting inverter with ESR
- 2-step trolley travel limit switch
- External fan for hoisting motor
- Standby heating for bridge panels and motors
- Special operating voltage 208 - 690 V 50/60 Hz
- IP66 protection
- Ambient temperature -20°C - +55°C
- Explosion proof version (Ex)
- Stainless steel hoist panel
- Rain covers
- Articulated trolley for curved track
- Drum brake
- Lockable hook/ramshorn hook
- Cable reel and much more

Frequency inverter technology for efficient hoisting

An innovation which sets economical standards

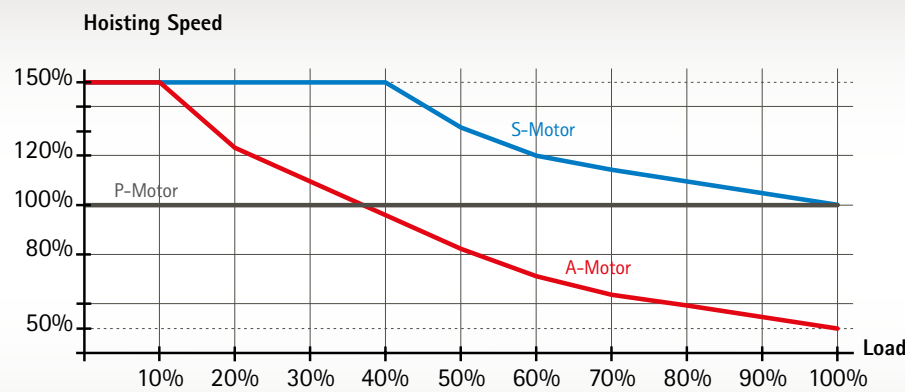

Speed range comparison A, S and P motors*

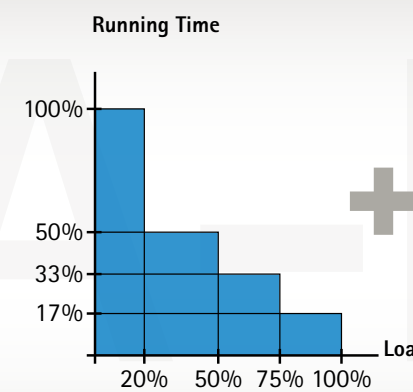

Average capacity utilisation of an industrial crane*

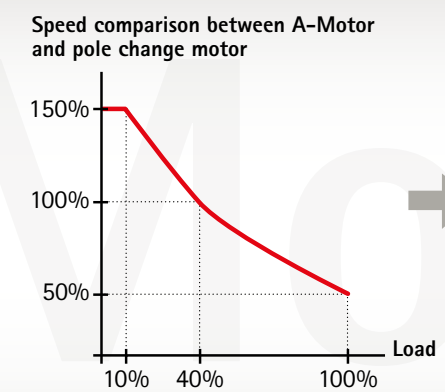

A motor characteristics*

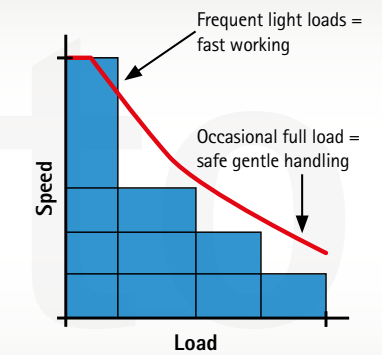

The use of frequency inverters for the hoisting process increases productivity. This leads to an extended lifetime of motors and brakes as well as cost savings for maintenance work and spare parts. Furthermore, the hoist works in a far more energy efficient manner than a conventional contactor-controlled solution.

- Safe hoist speeds for the smooth handling of heavy loads
- Quick hoist speeds with low loads increase productivity
- Reduced energy consumption
- Working time is reduced thanks to more effective and quicker working with load-dependent speed regulation
- Less wear and tear due to reduced mechanical load
- Reduced downtimes
- Reduced operating costs

Standard equipment:

- Load-dependent speed regulation (ESR)
- Duty cycle 60%
- Overheat protection
- Insulation class H
- Protection rating IP55
- Bearing sensor to monitor the rotating speed (A motor) or encoder to regulate rotating speed, closed loop control (S motor)
- External fan (S motor)

A-motor with HoistMaster 2p or HoistMaster 4

When using an A-motor in combination with a HoistMaster 2p the hoist inverter is installed in the bridge panel. In some hoists the hoist inverter HoistMaster 4 can be directly integrated into the hoist panel.

An A-motor operates, compared to polemotors, with only 50% lifting motor power and thus reduces energy costs by around half. Despite the halved hoist motor power, the load-dependent speed regulation (ESR) enables work to be carried out more effectively and quicker with an average industrial crane workload:

- Triple the nominal speed at 10% partial load
- Double the nominal speed at 40% partial load
- Standard nominal speed at 100% full load

The A-motor technology is a cost-effective solution, because of its favourable acquisition costs and savings in operation, which pay for themselves very quickly.

S-motor with HoistMaster 2p

When using an S-motor in combination with a hoist inverter HoistMaster 2p, the hoist speed and hoist motor performance are comparable with the standard speeds. Thanks to the separate fan that comes as standard on the hoist motor, the hoist can also be operated at full load for a very long time at a slower hoisting speed.

The encoder constantly regulates the rotating speed of the hoist motor and thus guarantees that the load is transported safely and accurately even at very low hoisting speeds (only 1% of the nominal speed).

The load-dependent speed regulation (ESR) enables:

- 1.5 times the nominal speed at 25% partial load
- Standard nominal speed at 100% full load

The S-motor together with hoist inverter HoistMaster 2p offers the possibility of connecting up to 4 hoists together via an optical cable and to synchronise the joint hoist lifting process.

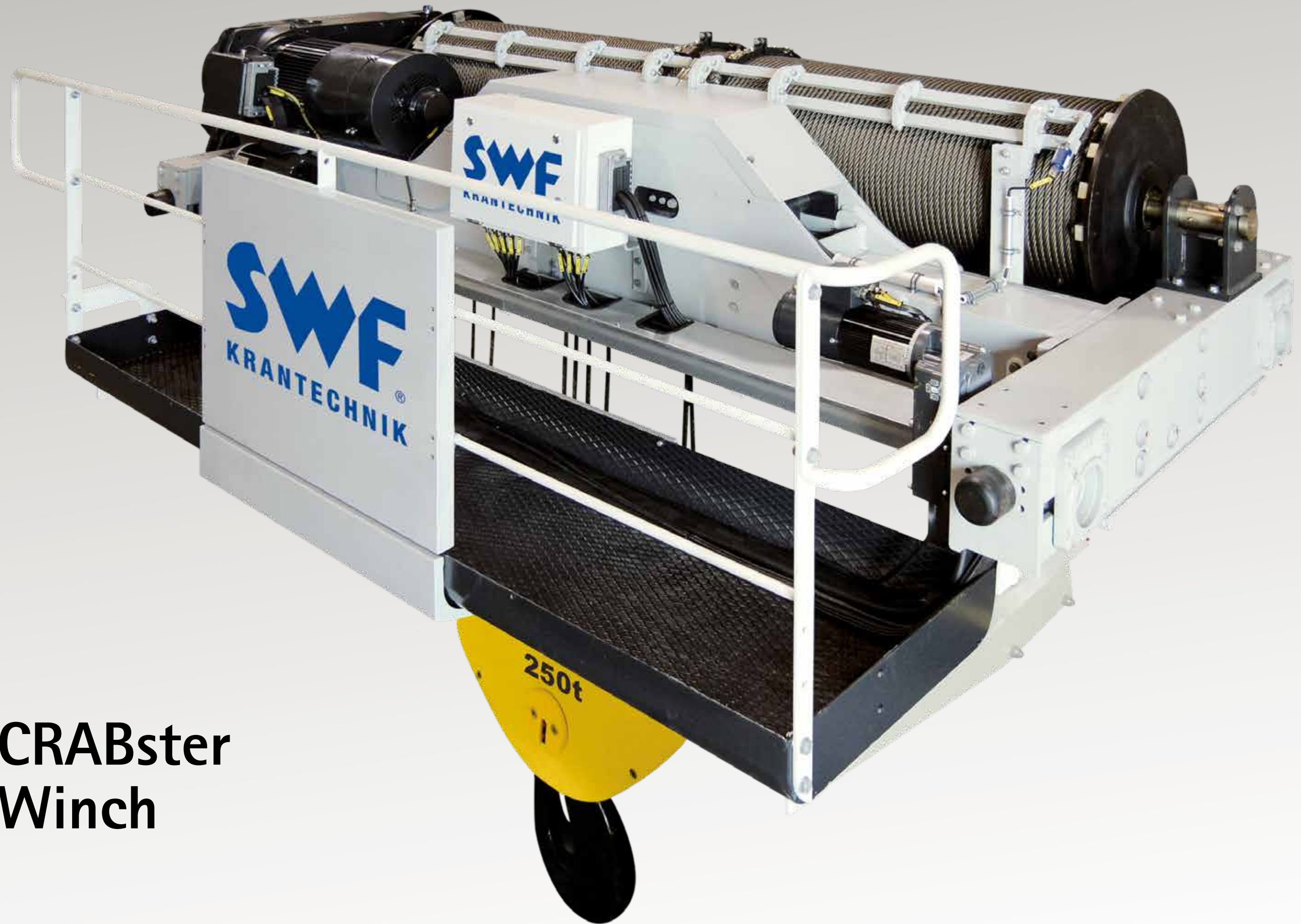

CRABster Winch

CRABster

Winch for loads up to 250 t



CRABster

- **Precise and safe operation**
Hoist condition monitoring system NovaMaster as overload protection with strain gauge load measuring, hoisting frequency inverter with closed loop, hoisting motor with encoder, frequency inverter controlled travelling machineries
- **Optimal usage of space and equal wheel load distribution**
Compact design and optimal approach dimensions, no horizontal hook movement
- **Various design options**
Well thought-out construction based on standardised components, calculation support via CraneMaster software

- Loads up to 250 t
- Four frame sizes
- Available as a solo winch or with a crane kit
- Double girder trolley or fixed hoist
- True vertical lift – no horizontal hook movement
- Compact design
- Optimal approach dimensions
- Stepless crane and trolley travelling
- Ambient temperatures from +5 °C up to +40 °C

- **Lower maintenance costs and short downtimes**
New hook block design with tilted sheaves for reduced rope wear, easy accessible central lubrication, just one type of hoisting motor, gear and frequency inverter per frame size

Advantage: highest possible efficiency and optimal usage of space



CRABster M double girder trolley up to 250 t



CRABster F fixed hoist for free-standing installations up to 250 t

Type	Reeving	Load t / FEM classification / Lifting speed m/min 50 Hz												Lifting height m		
		16	20	25	32	40	50	63	80	100	125	160	200		250	
CT18	22	3m 0-19,5	2m 0-14,4													38,6 - 80,3
	23			3m 0-12,5	2m 0-8,8											25,7 - 53,6
	24				3m 0-9,0	2m 0-7,2	1Bm 0-6,4									19,3 - 40,2
	25					3m 0,7,0	2m 0-5,6	1Bm 0-5,0								15,4 - 32,1
	26						3m 0-6,0	2m 0-4,5	1Bm 0-4,0							12,9 - 26,8
	28								2m 0-3,6	1Bm 0-3,2						9,7 - 20,1
CT19	22			3m 0-20,0	2m 0-14,4											42,6 - 104
	23					3m 0-12,8	2m 0-9,0									28,4 - 69
	24						3m 0-9,0	2m 0-7,2	1Bm 0-6,4							21,3 - 51,8
	25							3m 0-7,0	2m 0-5,6	1Bm 0-5,0						17 - 41,4
	26								3m 0-5,6	2m 0-4,4	1Bm 0-4,0					14,2 - 34,4
	28									2m 0-3,6	1Bm 0-3,2					10,6 - 25,9
CT20	22					3m 0-10,0	2m 0-9,0									55,6 - 129
	23							3m 0-6,4	2m 0-5,7							37,1 - 85,8
	24								3m 0-5,0	2m 0-4,5	1Bm 0-4,0					27,8 - 64,3
	25									3m 0-4,0	2m 0-3,6	1Bm 0-3,2				22,2 - 51,5
	26										3m 0-3,2	2m 0-2,8				18,5 - 42,9
	28											3m 0-2,6	2m 0-2,2	1Bm 0-2,0		13,9 - 32,2

Subject to change without prior notice. You will find further technical information in our manuals and dimensional drawings. Excerpt from the entire supply range. Type CT17 is not listed here.

CRABster

Winch for loads up to 250 t

Well thought-out technology and powerful components guarantee maximum safety and efficiency.

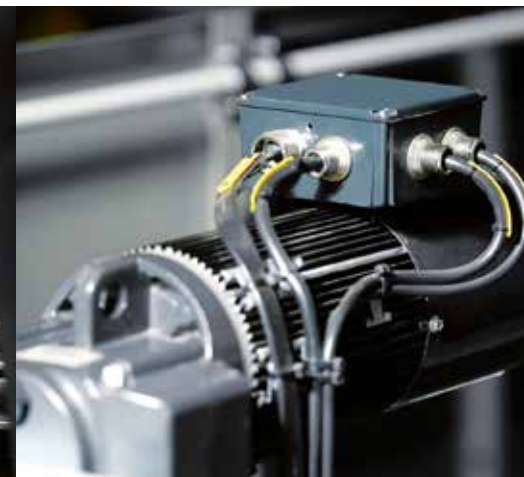
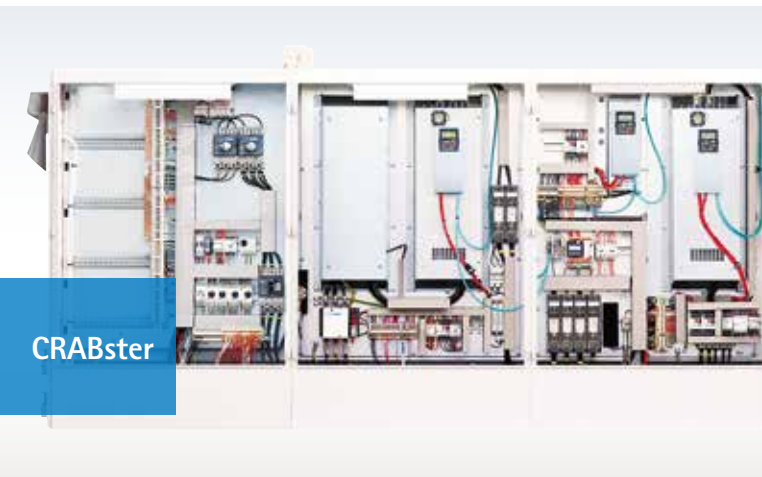

CRABster

17

State-of-the-art electrics

Gentle inclination

Trolley travelling motor with PLIOTEX type wire marking

Central lubrication

Free accessible pulleys and hook operated ultimate hoisting limit switch

The CRABster winch is delivered complete with control panels, all of which are pre-bolted and pre-wired accordingly. Standardised modules are used depending upon the performance features of the crane or of the individual winch. In the case of an individual winch, one control panel remains free for the individual equipment. The main components of the control panel are the frequency inverters for crane and trolley travelling, as well as lifting and lowering, the hoist condition monitoring system NovaMaster, the main contactor and the control transformer. There is also space for an optional radio remote control. Each control panel is equipped with 15W interior lighting. A 230V socket can be found on the narrow outer side of the standing unit.

Standard PLIOTEX cable markings guarantee a sustainable and quick overview of the wiring.

Stainless steel control panels, rain protection covers, heaters and air conditioning systems for operation in adverse conditions are available as optional extras.

The standard rope drive of our CRABster winch with its thought-out rope angles and tilted sheaves in the newly constructed hook block, ensures a considerably longer lifetime of the load rope and the sheaves. In addition, the rope guides are made of cast iron, which also have a positive effect on the service life. Maintenance costs and downtimes are noticeably reduced.

Due to the use of two ropes, CRABster lifts without horizontal hook movement. The low C-dimension is the result of the optimised headroom of the winch and enables the user to efficiently use space with respect to the lifting height. The innovative design of the CRABster makes access to the upper sheaves and the overload protection easier.

Standard equipment:

- Robust rope guides made of cast iron
- 4-step gear limit switch
- Additional safeguard by hook operated ultimate hoisting limit switch
- Hoist condition monitoring system NovaMaster
- 2-step trolley travel limit switch
- Frequency inverter for travelling machineries
- Hoisting inverter with closed loop technology, hoisting motor with encoder
- Thermal protection for hoisting and travel motors
- High duty time
- "Ready to use" bridge panels
- PLIOTEX type wire marking
- Bridge panels with inner light, 230V plug outside
- Horn 108 dB
- IP55 protection
- Epoxy paint, 120 µm

Options:

- Radio remote control
- Central lubrication
- Maintenance platform
- ESR overspeed for faster lifting speeds with lower loads
- Second hoisting brake
- Ramshorn hook
- Rope pressure roller
- Guide rollers for trolley frame
- Standby heating for bridge panels and motors
- Air condition for bridge panels
- Stainless steel bridge panel
- Rain protection covers
- Crane lights
- Horn, 120 dB
- Derailment catches and storm locks for hoist and crane
- Ambient temperature -20°C - +60°C and much more

CraneKit Crane components

End carriages
Travelling machineries

18

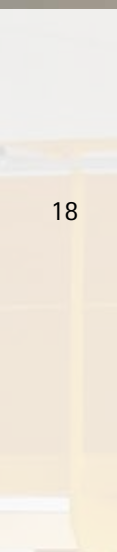

19



CraneKit

Crane components for loads up to 80 t



- **High efficiency**
One-Stop-Shopping principle: All components from one source
- **Shorter assembly times**
Pre-designed, pre-assembled and pre-wired components with screw and plug connection (plug and socket)
- **Numerous variations**
A well planned standard component basis, depending on the usage with electric chain or electric wire rope hoist, crane calculation support via CraneMaster software

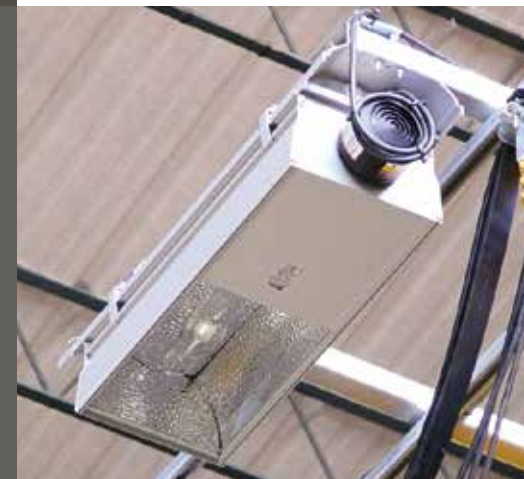

Crane light for bridge



Ready to use hoist power supply



Bridge panel with plugs

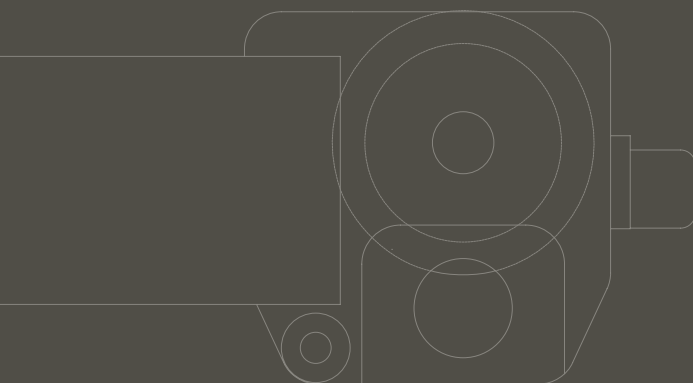

Advantage: a complete crane in an "All round-Carefree-Package", Power – out of the box

- Plug-in adapters and couplings for all components
- Completely wired, standard and custom made electrical components
- State of the art hoisting and travelling frequency inverters as standard for less wear and tear
- Numerous options available like tandem use, anti-collision device, rain covers, radio remote control, hoist monitoring, digital load display, etc.
- Modular crane kits assembled according to your specifications
- Continuous quality control from the first drawing to the final package
- Project support with crane configuration software CraneMaster



End carriage with travelling machinery

Standard content can include:

- 1 Hoist power supply with flat cable
- 2 Hoist power supply with energy chain
- 3 Control pendant with EMERGENCY-STOP
- 4 Radio remote control including transmitter and receiver
- 5 Backup pendant
- 6 Electric hoist
- 7 Hoist power supply towing arm
- 8 Trolley and crane travelling limit switches
- 9 Trolley end stop assembly

- 10 LED load display
- 11 Bridge panel
- 12 Crane lights for bridge
- 13 Crane power supply towing arm
- 14 Flashing light
- 15 Horn
- 16 End carriages
- 17 Crane travelling machineries

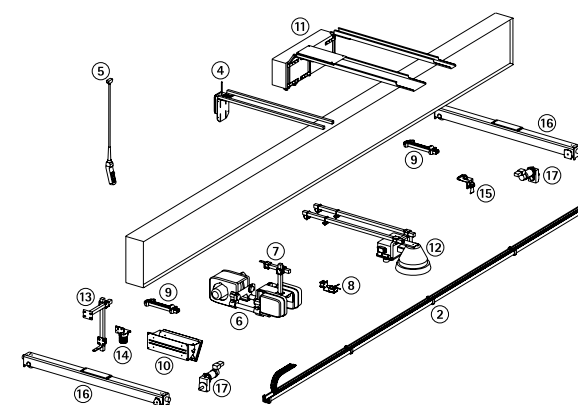

Single girder bridge crane with energy chain and radio remote control

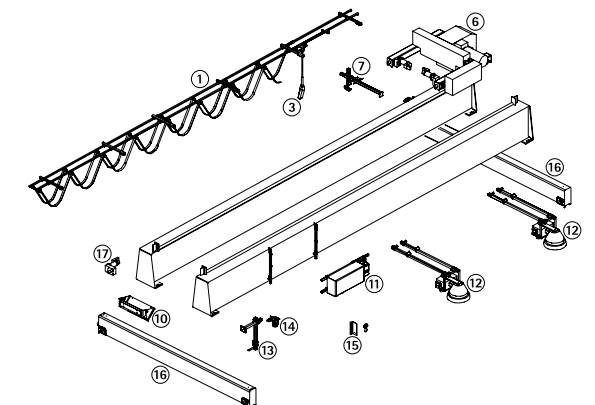

Double girder bridge crane with flat cable and control pendant

CraneKit

Component packages for single and double girder overhead travelling bridge cranes as well as underslung and gantry cranes

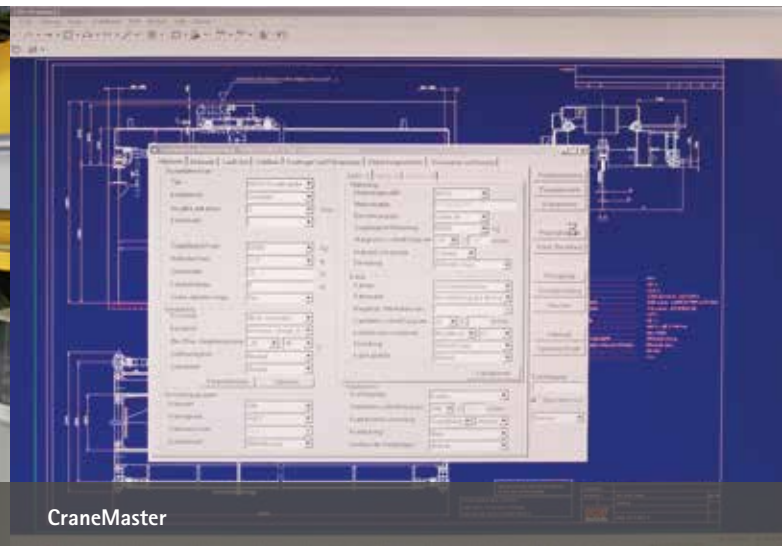

CHAINster N
with motor travel trolley
up to 5,000 kg



NOVA L
Single girder trolley,
low headroom, up to 12,5 t



NOVA N
Single girder trolley,
normal headroom, up to 40 t



NOVA M
Double girder trolley,
up to 80 t

Innovations. Always one step ahead.

SWF components also stand out due to their continuous further development. New technologies and technical implementations can primarily be evident in the SWF crane kits:

- Frequency inverters for lifting/lowering and travelling
- Synchronisation when lifting/lowering
- Tandem function through crane communication
- Electronic load swing damping
- New end carriage and bridge panels
- Power supply and control via an energy chain
- New radio remote controlled system
- Standard temperature monitoring and 2-step travel limit switch

CraneMaster – Sophisticated crane configuration software.

CraneMaster will improve the competitiveness of your crane, monorail system and crane components at the projecting stage. Optimised processing and reliable information flow allows CraneMaster to produce exact Microsoft compatible technical solutions at the best possible price, whether it be an offer, order confirmation, technical data sheet or technical layout drawing, CraneMaster can provide this information within a matter of minutes. The vast, constantly updated component data bank, comprising of electric wire rope hoists, chain hoists, end carriages, travelling machineries, electric components, frequency inverters and radio control systems will always give the optimum solution.

Electric chain hoist CHAINster up to 5,000 kg

- Compact headroom
- Robust industrial design
- 2 lifting speeds (4/1), optionally with frequency inverter for step less hoisting
- Upper and lower hoisting limit switch
- Drive operation with frequency inverter
- Mechanical overload protection
- Explosion proof version as an option 
- Versions for the food industry as an option

Electric wire rope hoist NOVA up to 80 t

- Compact design and optimum approach dimensions
- Minimum hook movement
- Lifting heights up to more than 100 m
- 2-speed hoisting motors (6/1), optionally with frequency inverter for step less hoisting
- 4-step hoisting limit switch with slow-down function and phase mismatch protection
- Travelling machineries with frequency inverter, 2-speed or variable
- Optional with hoist monitoring system NovaMaster and lifting inverter HoistMaster, also for synchronized use
- Explosion proof version as an option 



CraneKit

Crane types



CraneKit

Single girder underslung travelling crane



Double girder underslung travelling crane



Single girder overhead travelling bridge crane



25

Double girder overhead travelling bridge crane



Wall console crane



Pillar jib crane



Gantry crane



Semi gantry crane

Crane types

End carriages

Overhead crane end carriages for loads of up to 250 t

Underslung crane end carriages for loads of up to 20 t

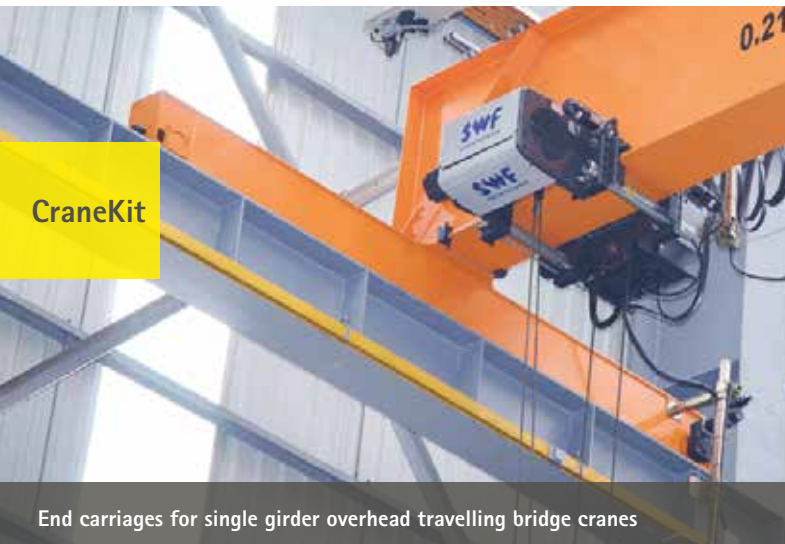

End carriages for single girder overhead travelling bridge cranes

End carriages for double girder overhead travelling bridge cranes

End carriages for single girder underslung travelling cranes

End carriages for underslung cranes with standard connection and painting as an option

- Primer coating, for single and double girder overhead cranes
- For new cranes and modernisations
- Various connection possibilities
- Running wheels in grey cast iron EN-GJS-700 (GGG70)
- Two and four wheel versions (Bogie)
- Anti-drop devices, storm protection, lateral guide rollers and rail guards all optional

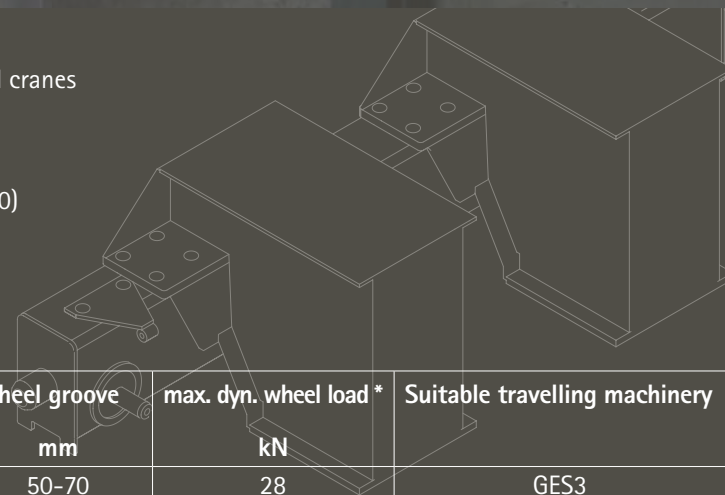

- Primer coating, for single and double girder underslung cranes
- For new systems and modernisations
- Various connection possibilities
- Running wheels in grey cast iron EN-GJS-700 (GGG70)
- With anti-drop device
- Lateral guide rollers and rail brushes all optional

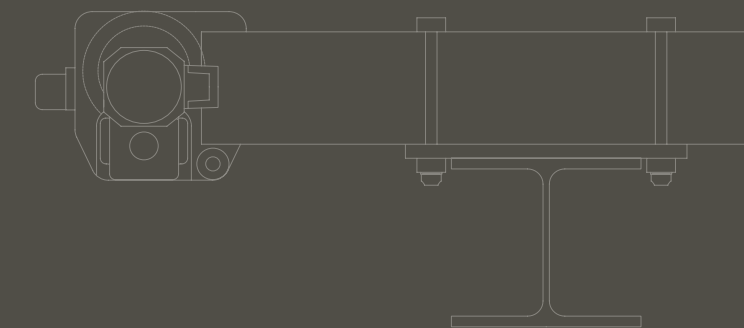

Wheel diameter mm	Type		Wheel groove mm	max. dyn. wheel load * kN	Suitable travelling machinery
90	ESN09	Side connection	50-70	28	GES3
	ETN09	Top connection	50-70	28	GES3
110	ESN11	Side connection	52-87	46	GES3
	ETN11	Top connection	52-87	46	GES3
140	ESN14	Side connection	54-84	55	GES3
	ETN14	Top connection	54-84	55	GES3
160	ESN16	Side connection	54-84	69	GES3
	ETN16	Top connection	54-84	69	GES3
200	ETN20	Top connection	54-94	120	GES3 / GES4
250	ETN25	Top connection	54-84	185	GES4 / GES5
320	ETN32	Top connection	64-94	225	GES4 / GES5
400	ETN40	Top connection	55-120	350	GES5
500	EH50	Heavy duty	100-150	463	QM6 / QM7
630	EH63	Heavy duty	100-190	600	QM6 / QM7
710	EH71	Heavy duty	150-190	835	QM10
800	EH80	Heavy duty	150-190	941	QM10

Wheel diameter mm	Type		Flange width		max. dyn. corner load * kN	Suitable travelling machinery
			min. mm	max. mm		
80	DU08	Standard	73	313	25	GEK2
110	DU10	Standard	82	332	46	GEK2
	DR10	Low headroom	82	322	46	GEK2
130	DU13	Standard	100	343	80,5	GEK2
	DR13	Low headroom	100	343	80,5	GEK2
200	DU20	Standard	127	418	143,8	GES3

* Corner loads (wheel pair) in accordance with FEM 2m (M5) for 40 m/min
Subject to change without prior notice. You will find further technical information in our manuals and dimensional drawings.

* Wheel loads in accordance with FEM 2m (M5) for 40 m/min
Subject to change without prior notice. You will find further technical information in our manuals and dimensional drawings.

Travelling machineries

Constant and reliable movement for customised systems



- **Precise trolley and crane control**

The standard frequency inverter motors, in conjunction with the standard frequency inverter TravelMaster, offer a 2-step or stepless trolley and bridge movement for a smooth and precise handling of the load.

- **Robust and durable**

Due to the hard-wearing body, the motors and gears are well protected against outer influences. Thanks to the standard thermal protection the heart of the travelling machinery is permanently monitored. A smooth and sustained usage is guaranteed by the low-wear gears.

Advantage: Precise as well as low-wearing and quiet trolley and crane movements.

- Frequency inverter motors as standard
- Overheat protection
- Standard operating voltage 380/400/415 V 50 Hz; 440/460/480 V 60 H
- Duty cycle 40%, insulation class F, protection rating IP55
- Motor housing in black anodised aluminium, gears painted
- Plug connection on the motor (for gear type GEK and GES with MF06/MF07 or MF10)

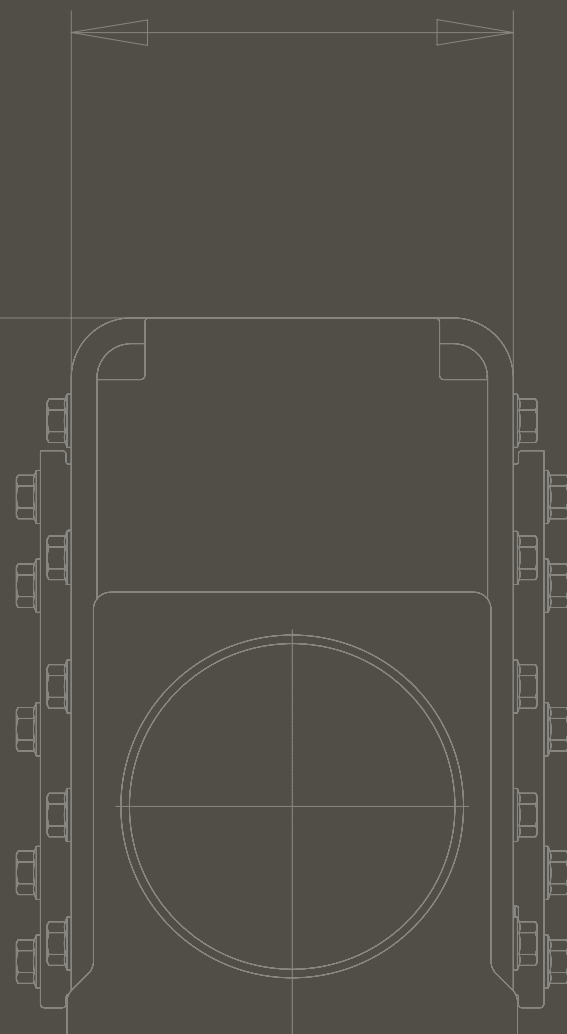

Travelling machinery
GEK2 with MF06



Travelling machinery
GES3 with MF06



Travelling machinery
QM7 with MF11

Gear type		Gear ratio	Motor type	Power kW	Duty factor	Synchronized motor speed 1/min
GEK2	Standard	6	MF06	0,3 - 0,65	40	4.800
GEK2-V	Standard	6	MF06	1,1	40	4.800
GES3-P	Standard	13-42	MF06	0,3 - 0,65	40	4.800
GES3-V	Standard	13-42	MF06	1,1	40	4.800
GES4-P	Standard	63-108	MF06 / MF07	0,3 - 1,1	40	4.800
GES5-P	Standard	56-115	MF06 / MF07 / MF10	0,75 - 3	40	4.800
GES4-G	Gantry crane	63-108	MF06 / MF07	0,3 - 1,1	40	4.800
GES5-G	Gantry crane	56-115	MF06 / MF07 / MF10	0,75 - 3	40	4.800
QM6	Heavy duty	22-90	MF10	4,5	60	3.000
QM7	Heavy duty	28-112	MF11	11	60	3.000
QM10	Heavy duty	14-280	MF10 / MF13	4,5 - 32	60	3.000

Subject to change without prior notice. You will find further technical information in our manuals and dimensional drawings.



NovaMaster
TravelMaster
RadioMaster
Sway Control
Tandem operation

Controlling/Monitoring

NovaMaster

Electronic hoist condition monitoring system

NovaMaster offers maximum security and guarantees a long hoist lifetime.



- **Safe working**
Hoist gear monitoring, permanent SWP calculation, continuous overload protection
- **Protective working**
Smooth lifting and stopping of the load
- **Short downtimes**
Quick reading of all crane-related data on the display
- **Low maintenance costs**
Smooth acceleration and braking reduce the wear and tear on motors and brakes

Advantage: Easily optimises the crane's profitability

NovaMaster records all the crane-related data and enables a precise and reliable calculation of the current load on the hook. At the same time, the hoist motor is constantly monitored, thus protecting the entire crane from overloading.

NovaMaster protects the mechanisms and the hoist's brakes thanks to its smooth lifting and stopping of the load. Braking or accelerating is automatic and always at the lower hoist speed, whereby the hoist brake is released.

With a load spectrum recorder, NovaMaster permanently calculates the „safe working period“ (SWP), which can be read accurately as part of the annual review. Inaccurate and time-consuming calculations are a thing of the past.



Radio remote control
RadioMaster with display



Current load on the hook

Total number of starts

Remaining safe working period (SWP)

Additional features:

- Relay outputs for other electrically controlled additional functions
- Intermediate loads can be programmed for the hoist
- Analogue output, for example for a large load display (0-10 V)
- RadioMaster remote control with a display indicating the current load
- Slack rope function with a bypass, e.g. for using load suspension devices
- CANbus function to network up to 5 hoists
- Multifunctional inlets e.g. for overload switching points or start/runtime counters
- Load measurements/summation optional via strain gauge sensor or motor current measurements

NovaMaster constantly monitors and stores all the hoists parameters:

- Remaining safe working period (SWP) of the hoist
- Total number of starts
- Total working period of the hoist motor
- Total number of hoist cycles
- Average load
- Remaining safe working period of the brake
- Current load on the hook
- Current supply voltage
- Total number of overload incidents
- Total number of emergency stop incidents
- Maximum value of the calculated duty cycle (ED)
- Total switch-on time of the crane
- Maximum measured value of the load and much more

TravelMaster

Frequency inverter controlling



- **Accurate operation under load**
Low-sway action with speed adjustable to any value in the range
- **Protective working**
Soft starting and stopping reduces stress on the gearing and wheels, thus reducing wear on the wheels and rails.
- **Low maintenance costs and short maintenance times**
Long service life for wheels and rails and practically no wear on the brakes results in lower maintenance outlay, with drastically reduced maintenance costs and use of materials.

Advantage: gentle operation ensures reduced wear and increased profitability.

TravelMaster4 frequency inverter controllers for cross and long travel ensure low-sway loading process. The soft starting and braking procedures can be set for any speed and also reduce the wear on many components, such as brakes, gearing and runners.

- The TravelMaster offers two types of controllers: stepless (EP) and two-step (MS2).
- The supply voltages for TravelMaster inverters are 380-480V +/- 10% at 50 or 60 Hz.
- All frequency inverters are fitted with an integrated EMC filter as standard.
- Modules have six digital inputs with a control voltage of 42-230V at 50 or 60 Hz.
- TravelMaster frequency converters are designed for ambient temperatures of -10°C to +50°C.



TravelMaster4k units are programmed by means of easily accessible dip switches. TravelMaster4k is the frequency inverter controller for crane and cross travel drives with an amperage from 2,4 up to 5,6 ampere at 400 volt.

TravelMaster5 units are programmed by means of an easy to operate removable display. TravelMaster5 is the frequency inverter controller for crane travel drives with an amperage from 3,4 up to 33,8 ampere at 400 volt. The system also offers an auto-tuning function and a code-supported error memory.

Typ	at 400 V	
	Nominal current I_n A	Max. current 1 min A
TravelMaster4k 003	2,4	3,6
TravelMaster4k 006	5,6	7,7
TravelMaster5 004	3,4	5,1
TravelMaster5 007	6,8	10,2
TravelMaster5 011	10,4	15,6
TravelMaster5 020	19,2	28,8
TravelMaster5 034	33,8	50,7

Subject to modification without notice. For further technical information please refer to our manuals and dimension sheets.



RadioMaster

Radio remote control



- **Room for manoeuvre**

No awkward control cable, flexibility in terms of the location of the crane operator, which ensures the crane is safely controlled.

- **Robust engineering**

Sturdy enclosure and control units, vibration protection for the receiver, long-life batteries, rapid-charging appliances with backup battery

- **Wide range of possible applications**

Load indicated in display by means of bi-directional communication, Control by means of push buttons and joystick, operation of more than one crane/lifting gear unit, e.g. in tandem or as master/slave, and control of additional functions possible.

Advantage: individual control possibilities for safe and constant operation

With our RadioMaster and RadioMaster3 remote controllers, we offer the right product for all requirements. At the same time, the controllers linked to our CraneKit are already pre-wired, securely attached and tested for functionality on delivery.

RadioMaster3 has been specially developed for efficient crane control without any major additional elements and represents a cost-effective solution for the user. When there are two hoists per crane, there is a selector switch integrated into the transmitter. As an option, RadioMaster offers a display in the control switch, to allow for the current load on the hook to be displayed, for example. In the 870 MHz band the operator has 24 freely-selectable frequencies available on the transmitter.

RadioMaster permits the control of additional functions, such as swivelling hooks. It is also possible for a number of cranes and lifting gear units to be controlled in tandem. Functions like master/slave operation, mutual crane locking arrangements and electronic load-sway prevention can be provided ex-works. With RadioMaster, use is also made of push-button switches as well as joysticks. As an option RadioMaster can communicate with innovative DECT technology, which automatically selects the frequency free in each case for communication between transmitter and receiver.



RadioMaster3
RM3J14MCL

RadioMaster3
RM3J21MCM

RadioMaster
RM516MI

RadioMaster
RM516M2

RadioMaster
RM516SP

Standard equipment:

- Fully equipped transmitters with 2-stage push-button switches or joysticks
- ON switch with horn function
- EMERGENCY STOP switch
- IP65 protection type
- Ambient temperature -10°C to +40°C
- Belt clip or carrying strap
- Transmitter and receiver
- Charger with 2 batteries
- Transmission frequency freely selectable or automatic frequency selection
- Simple transmitter switching with data inclusion via electronic key

Special equipment:

- Display for NovaMaster data and to indicate load
- Explosion-proof design 
- User identification
- Additional functions such as buttons and rotary switches
- Mutual crane locking/data transmission

Sway Control

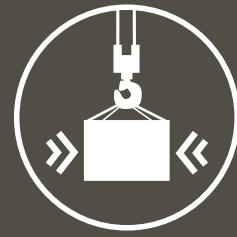

Electronic load-sway protection

Tandem operation



For hoists and cranes



Sway Control

Load sway



Selector switch for entering additional sway length



2 hoists in tandem operation



Tandem operation

Electronic crane interlocking

The electronic Sway Control load-sway protection feature prevents harmful load peaks and therefore reduces the stress exerted on both electrical and mechanical components. This cuts the time and money spent on maintenance. The crane is easy to control and allows the load to be placed in just the right position. The crane operator can focus his concentration entirely on the load and does not have to take into consideration the cross and long travelling movements. This represents a considerable saving in time and enhances the safety of the operation in progress.

Sway Control monitors all movements as well as lifting height (sway length), speed of travel and the load carried. The system uses these values to regulate acceleration and braking curves correspondingly, thus preventing sway on the load suspended.

- Frequency inverter for cross and long travel
- NovaMaster hoist monitoring unit
- Geared limit switch with encoder for automatic detection of current lifting height
- Central data processing unit for the individual values measured and for controlling cross and long travel via the frequency inverter
- Radio remote control with selector switch for entering additional sway length through the lifting sling currently in use
- Control light for displaying whether the system is switched on or off

Simultaneous operation with two or more hoists

This system is used where loads have to be transported with more than one lifting-gear unit at the same time and delivered to an exact spot. Up to four units can be controlled by the crane operator in tandem operation at the same time. In this way the hoists start and stop at exactly the same time during the lifting and lowering process. The lifting speed is measured by encoders and is kept equal continuously between all the hoist motors. The calculated data is exchanged between the lifting units via a CANbus link in the individual frequency inverters. There is no need for a separate regulator unit.

- Simultaneous lifting and lowering
- Load summation
- High degree of operational safety
- Constant hook levelling
- No need to correct individual lifting units
- Rapid and accurate load carrying

Shared use of two cranes

Where two cranes are in shared use at the same time, it is always possible for dangerous situations to arise as soon as one of the cranes involved unexpectedly slows down or stops. The electronic crane interlocking feature prevents exactly this situation. There is constant radio monitoring and exchanging of all relevant data. Relays in an additional control panel for each crane ensure that fed back messages are processed, and they handle the communication between the two systems.

The following components and functions are included in the monitoring system and therefore offer a thoroughly safe system:

- Main contactor
- Long and cross travel
- Lifting/lowering
- All travelling limit switches
- Overload safety feature
- Frequency inverter function
- Overheating protection for all motors
- Anti collision device

Look ahead!



654

610

B=1000

40

620

3

07/2017 - WWW.RALF-GROSSE-SCHLUE.DE

ENGLISH

SWF Krantechnik GmbH

P.O. Box 310410
D-68264 Mannheim

Boehringerstr. 4
D-68307 Mannheim

Phone +49(0)621.78990-0
Fax +49(0)621.78990-100

info.de@swfkrantechnik.com
www.swfkrantechnik.com